

BESTFOAM

technology for pu foam processing

SPRING PRODUCTION PRODUCT LINE



POCKET SPRINGS

AUTOMATIC POCKET SPRING MACHINE

BONNELL COILING & ASSEMBLING MACHINES

BONNELL TRANSFER LINE

SPECIAL POCKET SPRINGS

ROLL PACKING MACHINE

DOUBLE COLOUR FABRIC WELDING MACHINE



POCKET SPRINGS

TOP1/TOP2

Ø48-72 mm

240 mm



STANDARD
SINGLE/DUAL

80 mm

SX-SH

Ø60-75 mm

290 mm

*+50 mm extra height
less material layer*



SUPER HIGH
SINGLE

80 mm

HP1/HP2

Ø62-75 mm

220 mm

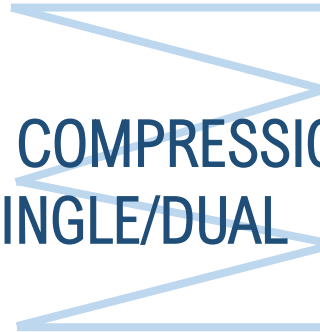

HIGH COMPRESSION
SINGLE/DUAL

150 mm

*-30% less weight
+15% more firm*

SX-SL

Ø50-60 mm

120 mm

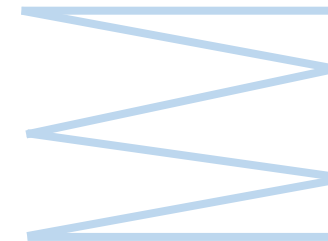

SUPER LOW
SINGLE

45 mm

ULC1/ULC2

Ø60-75 mm

*-50% less weight
-50% wire cost*



ULTRA LOW COST
SINGLE/DUAL

180 mm

80 mm

AUTOMATIC POCKET SPRING MACHINE

Pocket Spring Machine
SX-TOP1 Single



Pocket Spring Machine
SX-TOP1 Single



Pocket Spring Machine
STANDARD

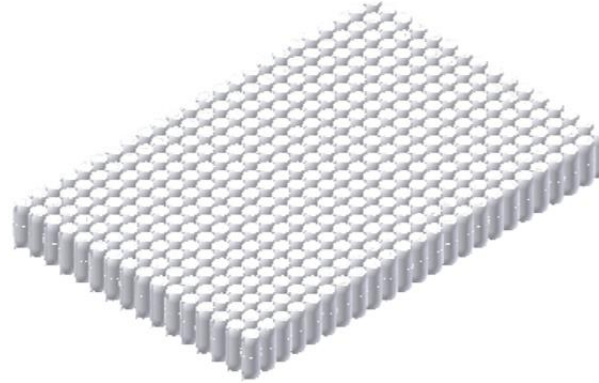

Spring Production Line
TOP1/TOP2 + SX300

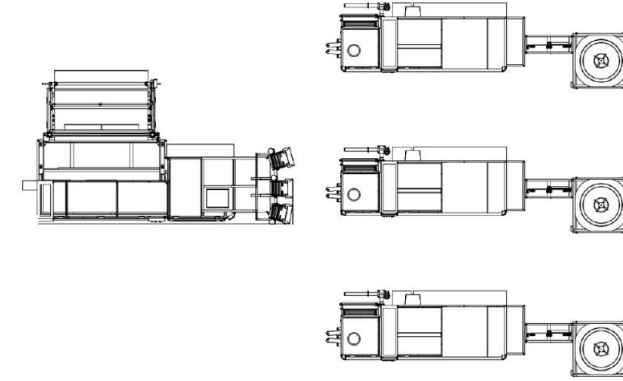

Pocket Spring Machine
SX-TOP2 Dual



Pocket Spring Machine
SX-TOP2 Dual



Pocket Spring Machine
ZONING

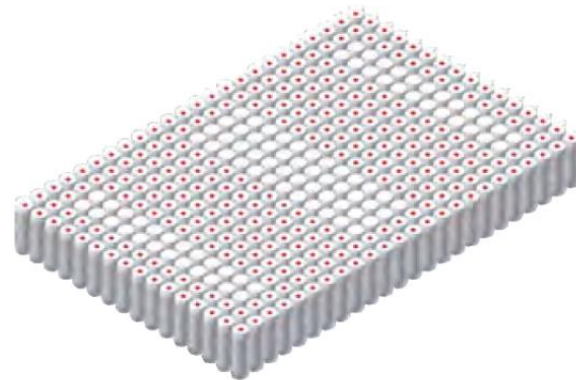

Spring Production Line
TOP1/TOP2 + SX700

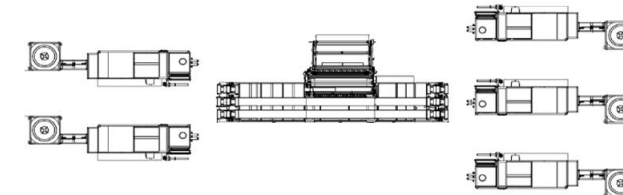

AUTOMATIC POCKET SPRING ASSEMBLY MACHINE

Pocket Spring Assembly Machine
SX-300DL



Pocket Spring Assembly Machine
SX-300DL



Pocket Spring Assembly Machine
3 COILERS

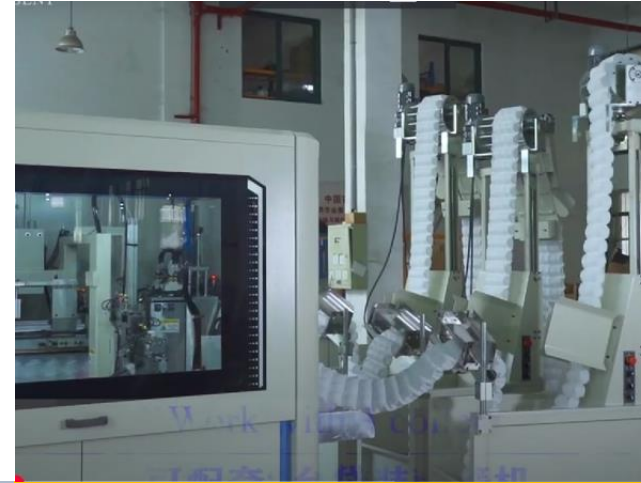

Spring Production Line
SX-300DL + TOP1/TOP2

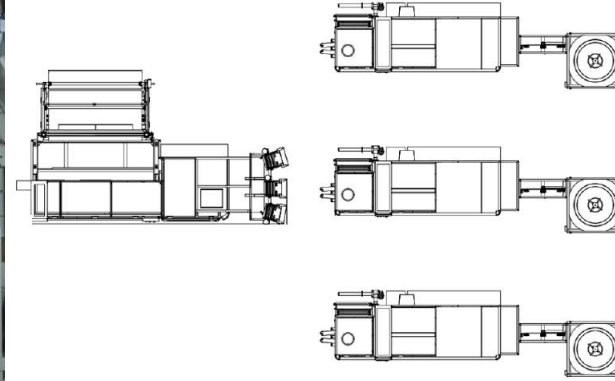

Pocket Spring Assembly Machine
SX-700D



Pocket Spring Assembly Machine
SX-700D



Pocket Spring Assembly Machine
6 COILERS



Spring Production Line
SX-700D + TOP1/TOP2

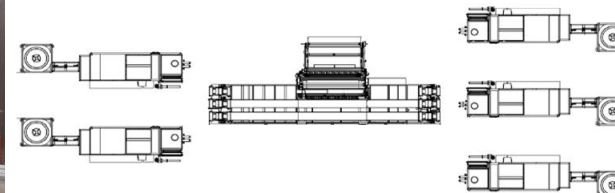

BONNELL COILING & ASSEMBLY MACHINES

Bonnell Coiling machine
BONNELL SPRING

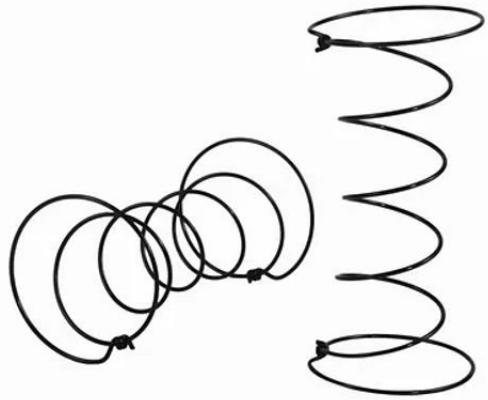

Bonnell Coiling machine
SX-100



Bonnell Coiling machine
SX-100



Bonnell Coiling machine
SX-100

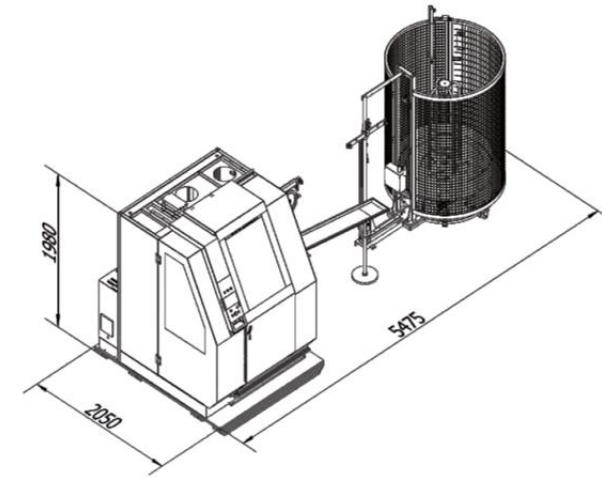

Bonnell Assembling Machine
BONNELL SPRING NET



Bonnell Assembling Machine
SX-200S



Bonnell Assembling Machine
SX-200S



Bonnell Assembling Machine
SX-200S

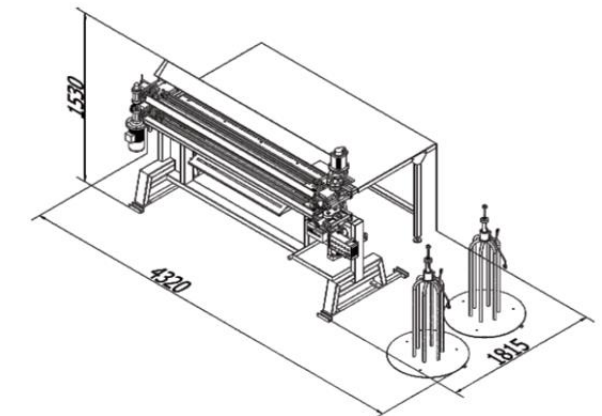

BONNELL TRANSFER LINE

Bonnell Transfer Line
BONNEL SINGLE/DUAL

Bonnell Transfer Line
SX-90 SX-100T

Bonnell Transfer Line
SX-100TA

Bonnell Transfer Line
SX-100F

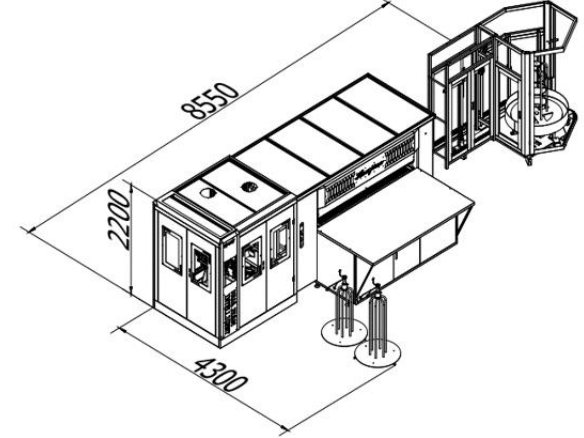
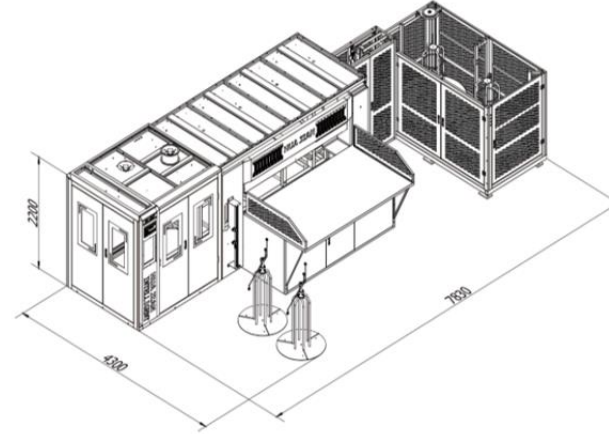
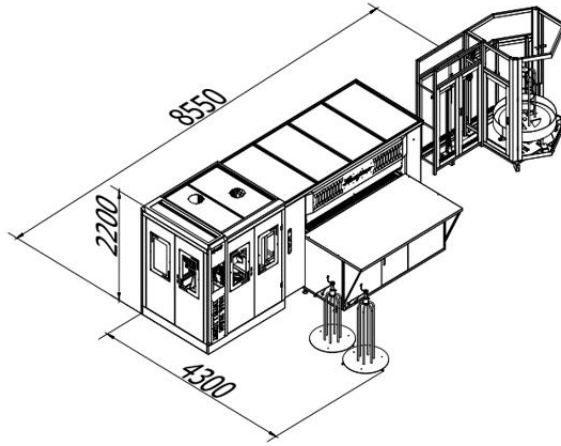

Bonnell Transfer Line
SX Series

Bonnell Transfer Line
STANDARD

Bonnell Transfer Line
ZONING

Bonnell Transfer Line
OPEN COIL

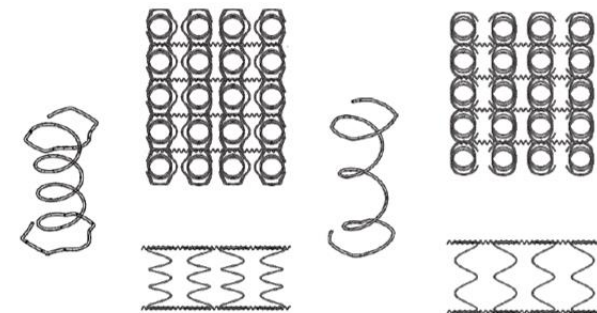
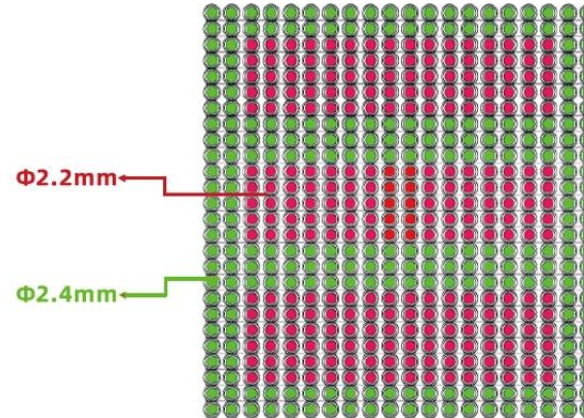
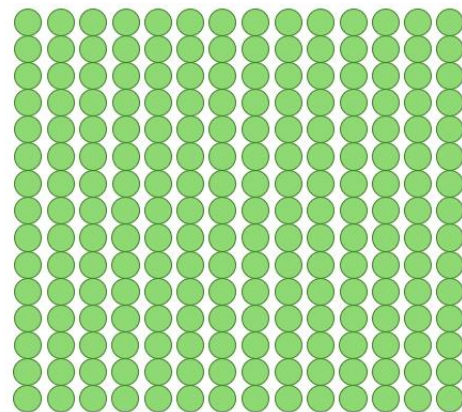

SPECIAL POCKET SPRINGS

Ultra Low Cost Pocket Spring
ULC1 ULC2 SINGLE/DUAL

High Compression Pocket Spring
HP1 HP2 SINGLE/DUAL

Super Low Pocket Spring
SX-SL

Super High Pocket Spring
SX-SH



Ultra Low Cost Pocket Spring
-50% LESS WEIGHT

High Compression Pocket Spring
-30% LESS WEIGHT

Super Low Pocket Spring
45 MM HEIGHT

Super High Pocket Spring
+50 MM EXTRA HEIGHT



ROLL PACKING MACHINE

Spring Roll Packing machine
HJ-7D



Spring Roll Packing machine
HJ-7D



Spring Roll Packing machine
BONNELL SPRINGS



Spring Roll Packing machine
POCKET SPRINGS



Spring Roll Packing machine
CHAIN CARRY SYSTEM



Pocket High Compression
10 PACKS = DIAM 600mm



Spring Roll Packing machine
H = 240 MM



Spring Roll Packing machine
MANUAL EXIT



DOUBLE COLOUR FABRIC WELDING MACHINE

Double Color Welding Machine
2-COLOR FABRIC



Double Color Welding Machine
SX-12DC



Double Color Welding Machine
INLET



Double Color Welding Machine
OUTLET



Double Color Welding Machine
FIRM EDGE

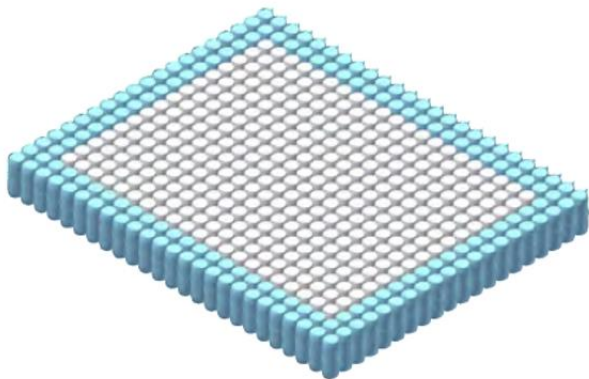

Double Color Welding Machine
ZONING A/B

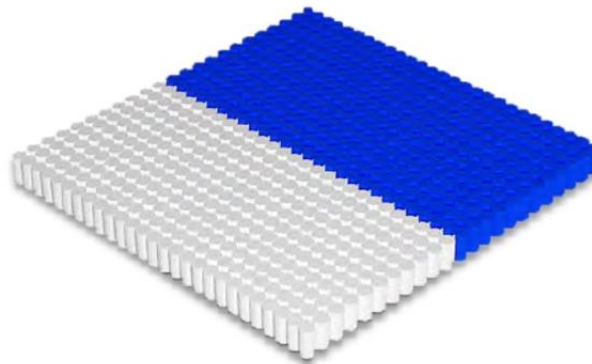

Double Color Welding Machine
ZONING A/B/C/D

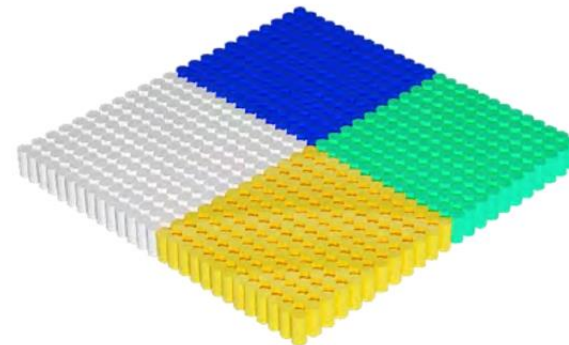

Double Color Welding Machine
SX-12DC



AUTOMATIC FOAM EDGE GLUING MACHINE

Foam Edge Gluing Machine
SX-FS 1,5 MIN/SHEET



Foam Edge Gluing Machine
4000*6100*3500 MM

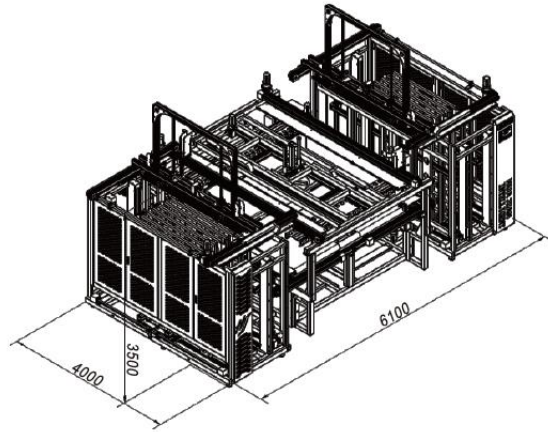

Foam Edge Gluing Machine
800–2200 MM WIDTH

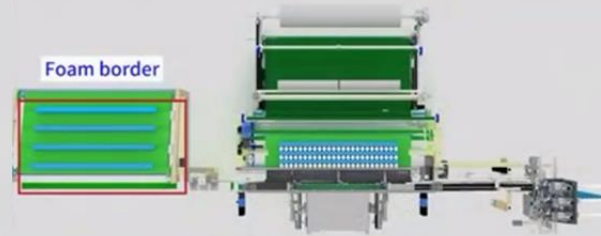

Foam Edge Gluing Machine
1200–2200 MM LENGTH



Foam Edge Gluing Machine
80–240 MM HEIGHT

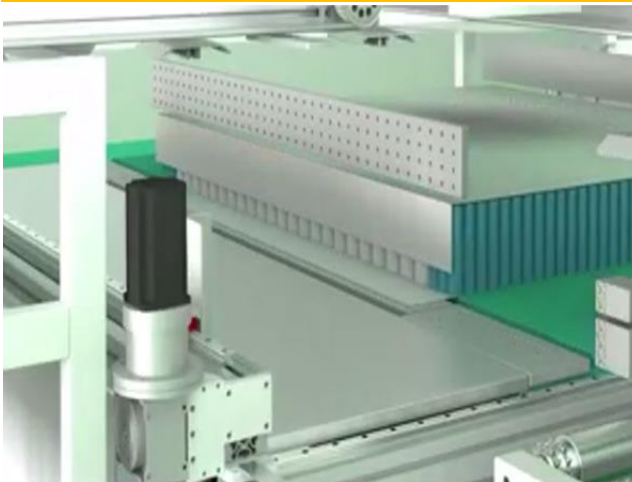

Foam Edge Gluing Machine
FOAM TO FOAM

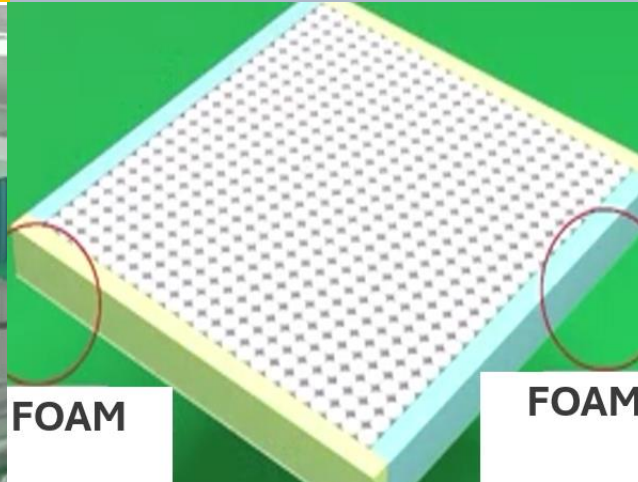

Foam Edge Gluing Machine
FOAM TO SPRING

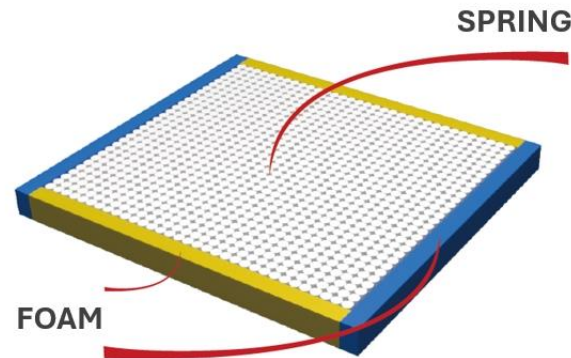

Foam Edge Gluing Machine
SPRING TO SPRING

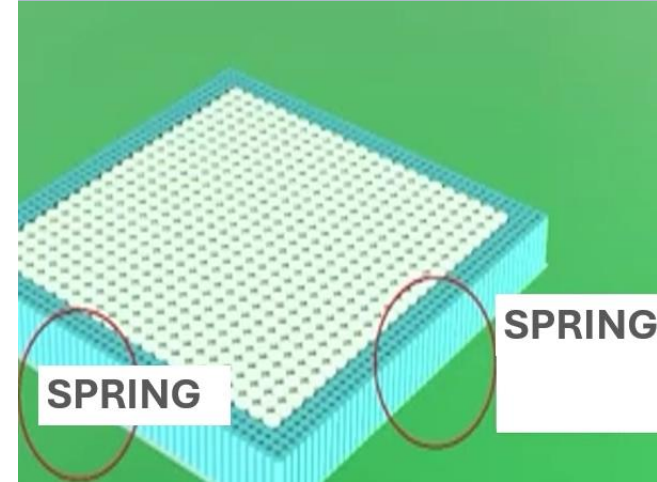

AUXILIARY EQUIPMENT

Auxiliary Equipment
LAYER MACHINE SX-1

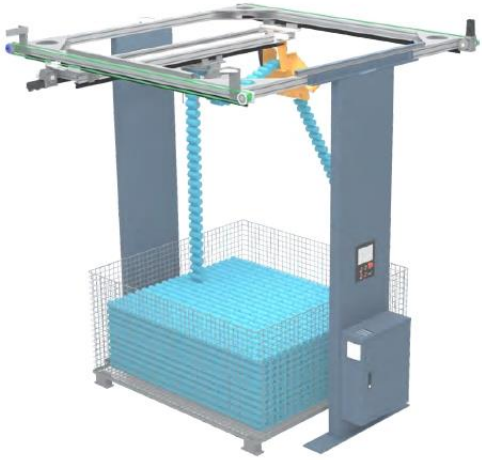

Auxiliary Equipment
SX-1 AFTER TOP1/TOP2



Auxiliary Equipment
STOCK MACHINE SX-7S



Auxiliary Equipment
CUTTING MACHINE SX-3



Auxiliary Equipment
SX-1 BEFORE SX-300DL



Auxiliary Equipment
SX-1 BEFORE SX-12DC

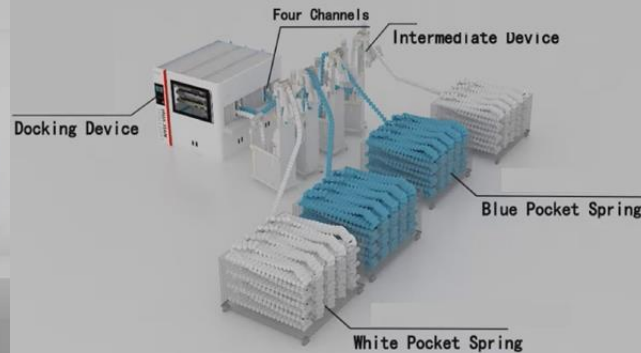

Auxiliary Equipment
SX-7S AFTER SX-TOP



Auxiliary Equipment
SX-3 AFTER SX-TOP

